

E1 Outdoor

E1 Outdoor with smart technology detects humans and vehicles, allows real-time remote communication and offers color night vision with spotlights on. This PTZ camera allows you to view your world from every angle and can follow the moving person/car automatically.

1. Specs



1	Daylight Sensor
2	4 Spotlights
3	Lens
4	12 IR LEDs
5	Status LED



1	Micro SD Card Slot
2	Power
3	Network
4	Power Cable
5	Speaker

2. Setup and Install

Set up the Camera

What's in the Box

Note: The package content may vary and update with different version and platforms, please take the below information only for a reference. And the actual package content are subject to the latest information on the product selling page.

E1 Outdoor



E1 Outdoor*1



1m Network
Cable*1



Quick Start Guide*1



Surveillance Sticker*1



Pack of Screws*1



Mounting Template *1



4.5m Power Extension Cable *1



Power Adapter *1



Security Bracket *1



Strap *1



Reset Needle *1

Set up the Camera on the App

There are two methods to do the initial setup of the camera:
1. with a Wi-Fi connection; 2. with a network cable connection.

1. With Wi-Fi Connection

Step 1. Tap the  icon in the top right corner to add the camera.

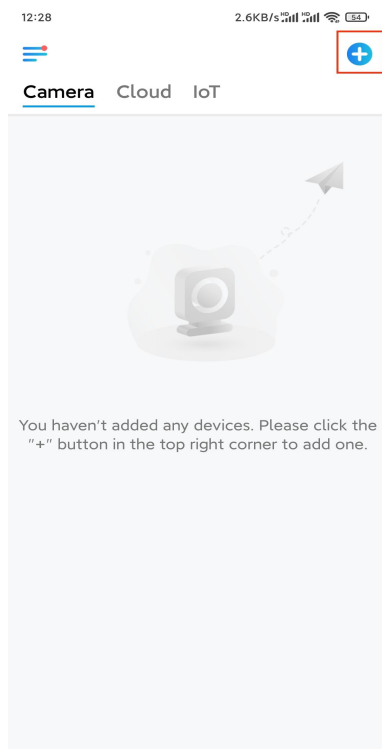

Step 2. Scan the QR code on the camera.

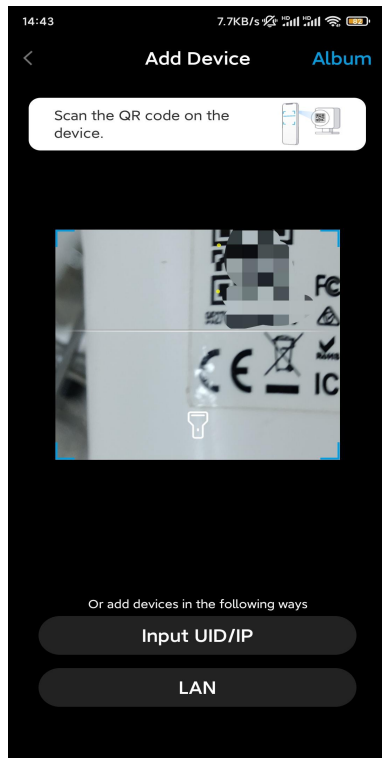

Step 3. Tap **Choose Wi-Fi Connection** to configure the Wi-Fi settings.

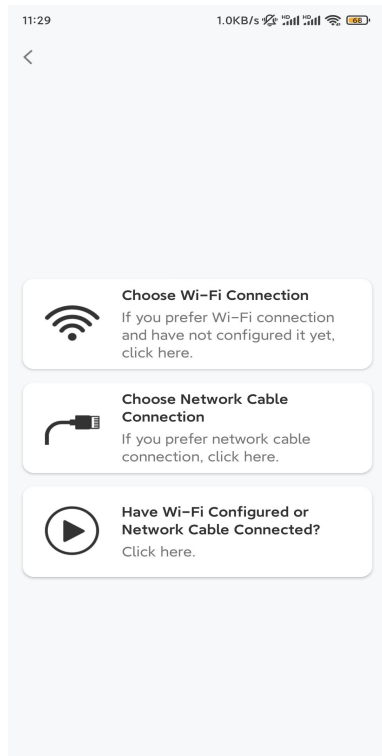

Step 4. After you hear the voice prompts from the camera, tick "I have heard the voice played by the camera" and tap **Next**.

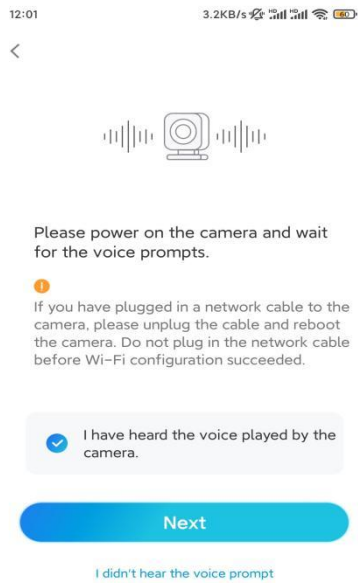

Step 5. Select a WiFi network, enter the WiFi password, and tap **Next**.

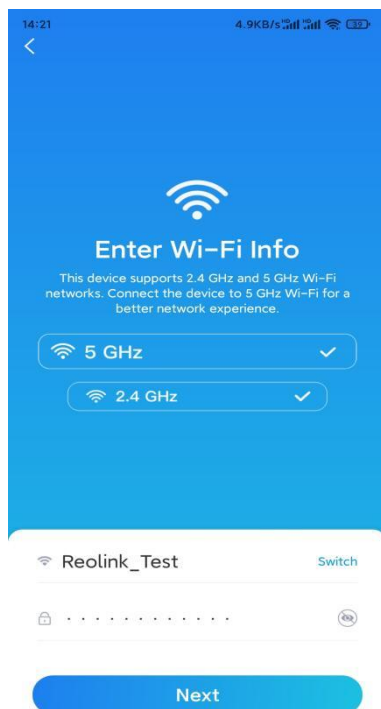

Step 6. Scan the QR code on the app with the camera lens. Tap **Scan Now**. The QR code will be generated and displayed on your phone. Please hold your phone in front of the camera at a distance of about 20 cm (8 inches) and have the phone face the camera lens to let the camera scan the QR code.

After you hear the beep sound, tick "I have heard a beep sound from the camera" and tap **Next**.

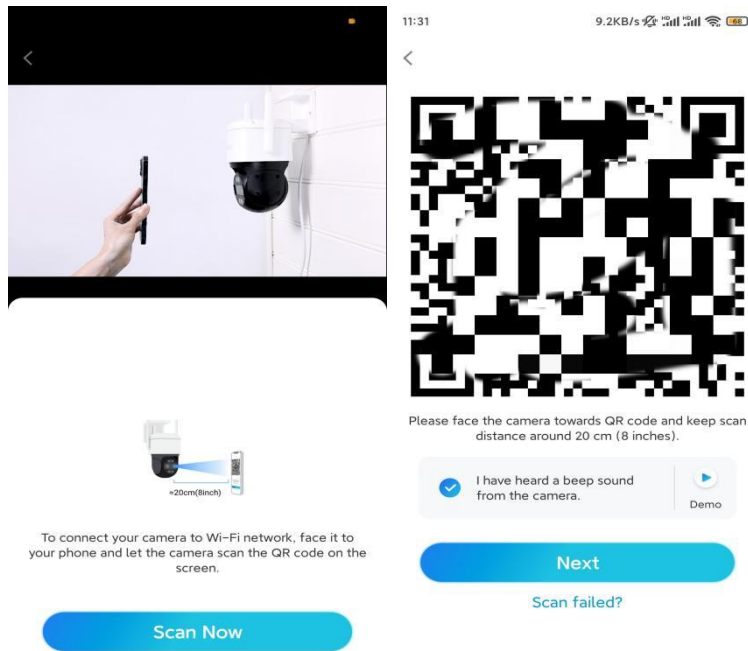

Step 7. After you hear a voice prompt "Connection to the router succeeded" from the camera, tick "I have heard the voice prompt" and tap **Next**.

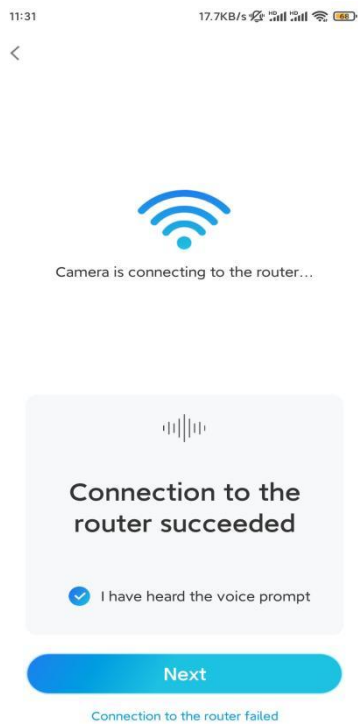

Note: If you hear the voice prompt "Connection to the router failed", please double-check if you have entered the Wi-Fi information correctly in the previous

step.

Step 8. Create a login password and name your camera.

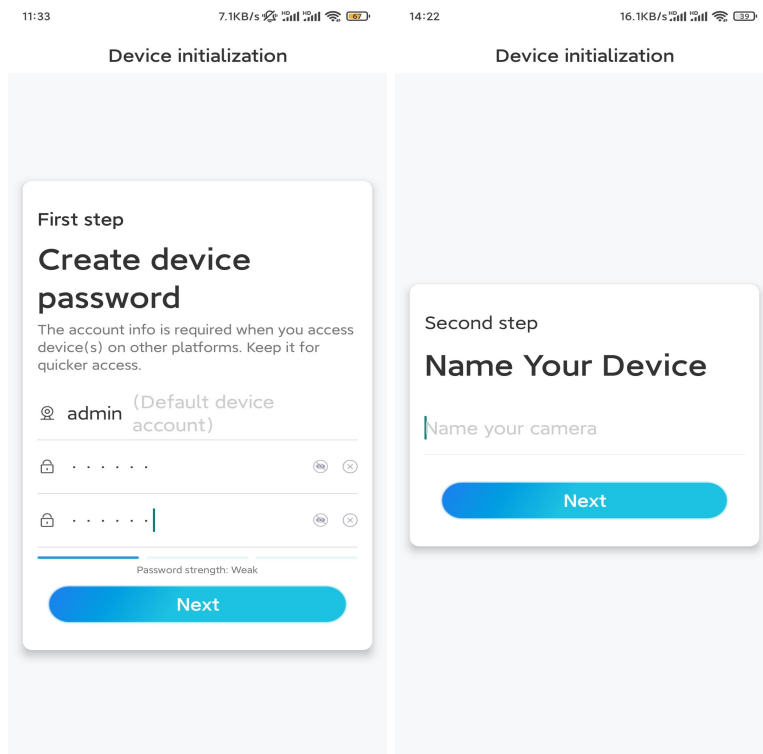

Step 9. Initialization finished. Tap **Finish**, and you can start live viewing now.

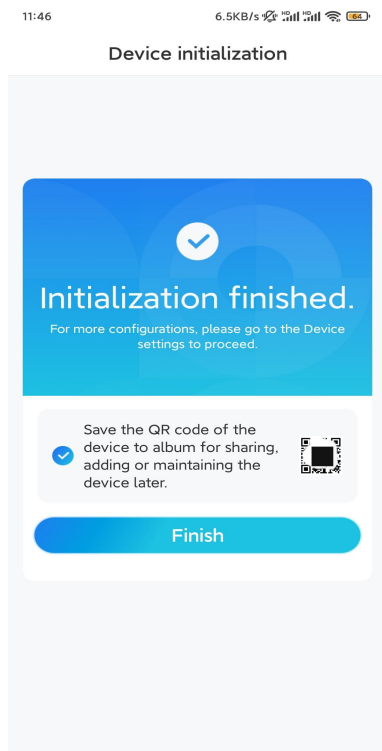



2. With a Network Cable Connection

To do the initial setup, please power on the camera with the DC adapter, connect

the camera to your router's LAN port with an Ethernet cable, and follow the steps below.

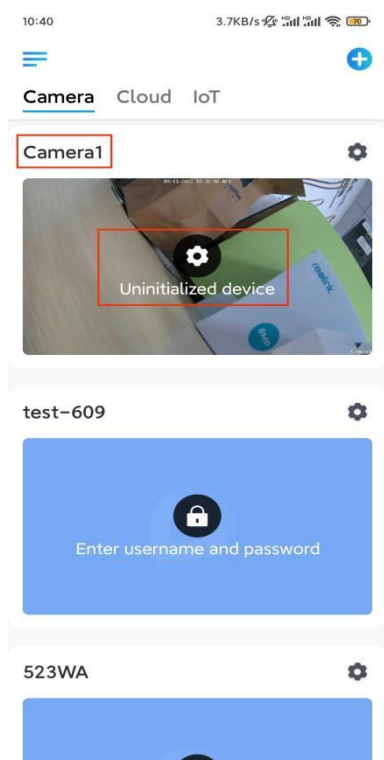
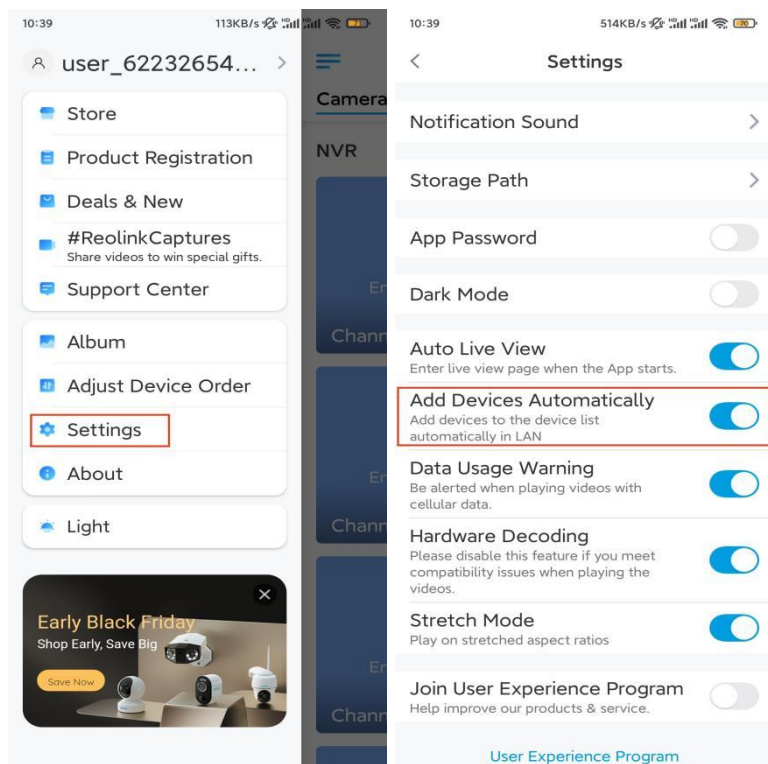
Step 1. If your phone, the camera, and the router are on the same network and you've enabled the **Add Device Automatically** option in the App **Settings**, you can tap and select this device on the **Devices** page and skip to **Step 3**.



Otherwise, you can tap the  icon in the top right corner and scan the QR code on the camera to add the camera.

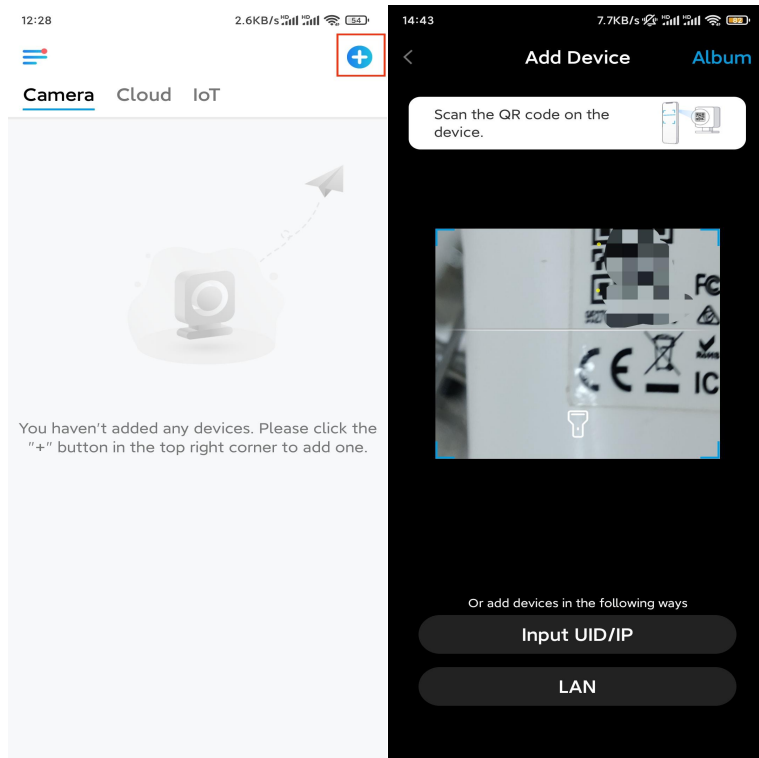

Step 2. Tap Choose Network Cable Connection.

Please make sure the camera is connected in the correct way, as shown in the diagram, and then tap **Access the Camera**.

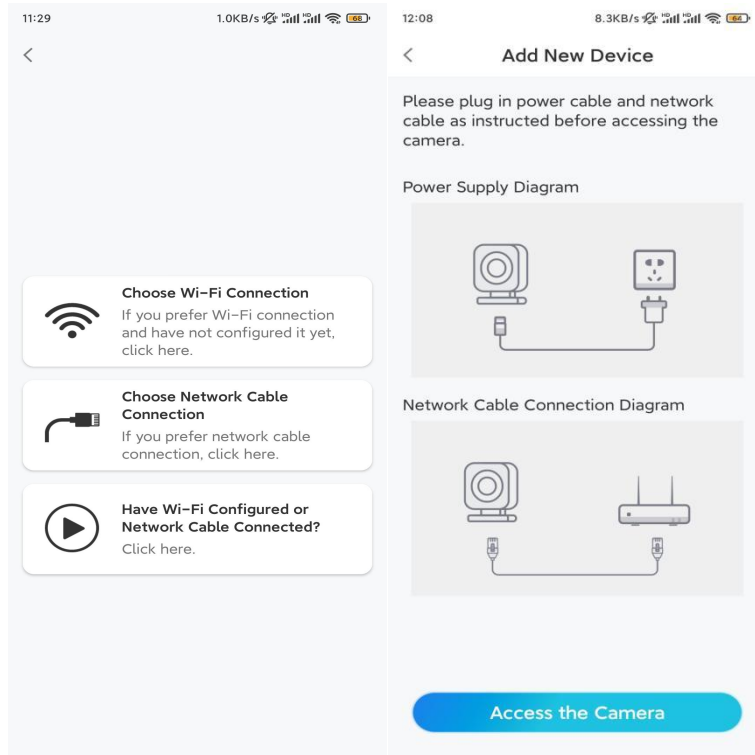

Step 3. Create a device password and name the device.

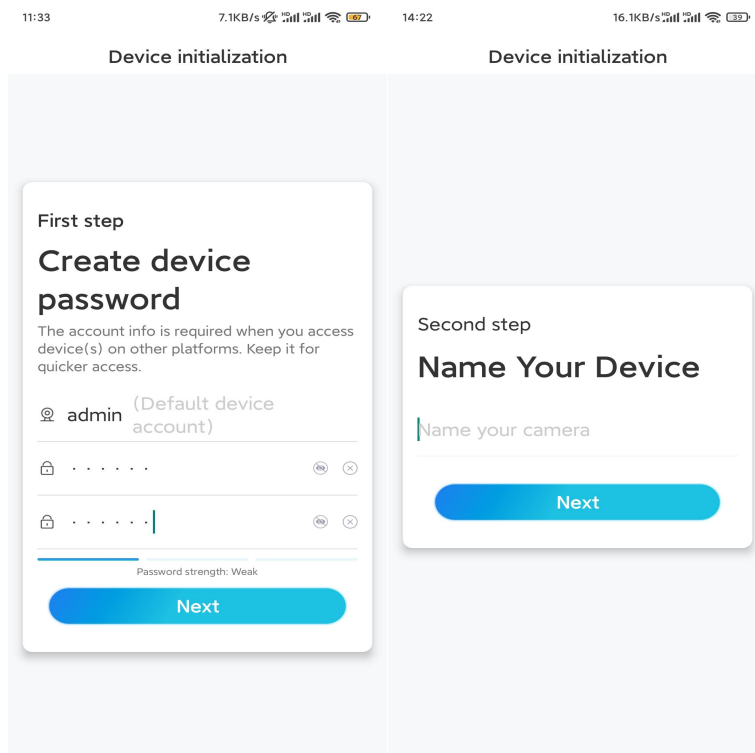

Step 4. Select the WiFi network that you want to join, enter the password of the WiFi network, and tap **Save** to save the configuration.

Device initialization

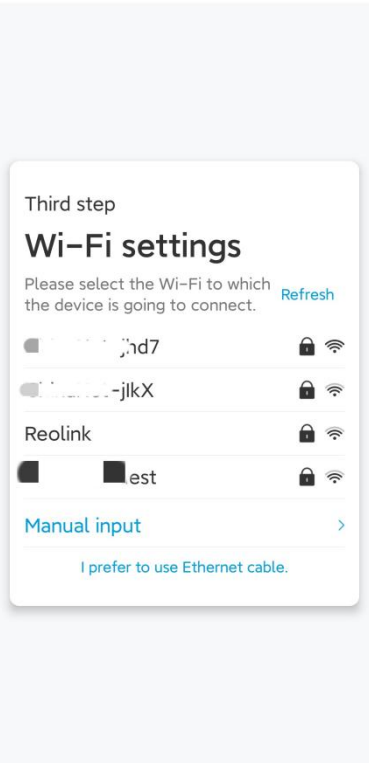

Cancel Enter the password Save

Please enter the password of Reolink.

.....|

Step 5. Initialization finished. Tap **Finish**, and you can start live viewing now.

Device initialization

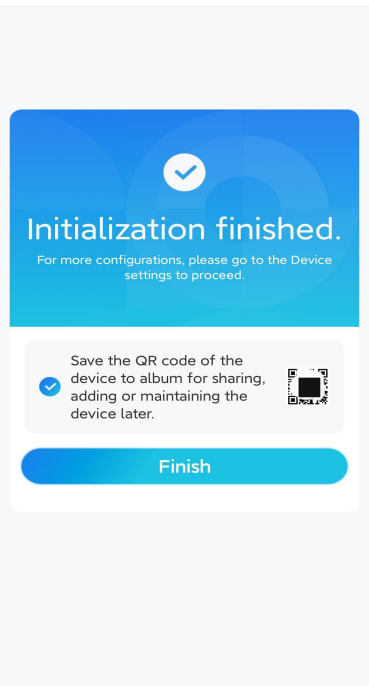

Install the Camera

If you have no clue about how to install E1 Outdoor on the ceiling or on the wall, you should read this article and follow the steps therein.

Note: For outdoor use, E1 Outdoor must be installed upside down for better waterproof performance.

Mount the Camera on the Wall

Step 1. Take down the bracket.

Use your fingertip to pull the button on the security mount downwards, at the same time use another hand to turn the bracket and take it out from the mount.

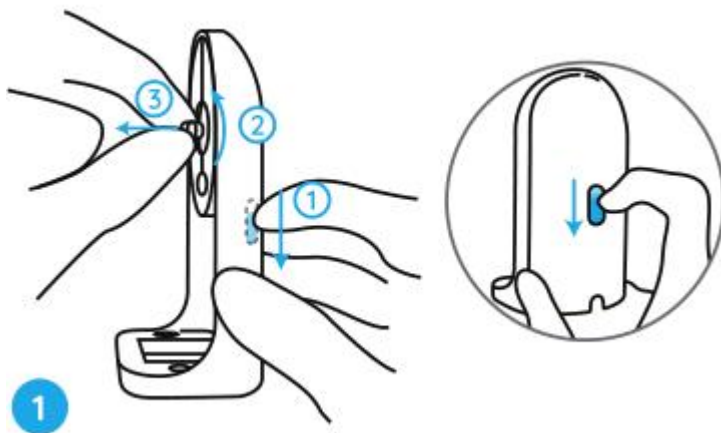

Step 2. Screw the camera to the bracket.

Align the stud on the bracket to the threaded hole on the camera, then screw the bracket clockwise to hold them tightly together.

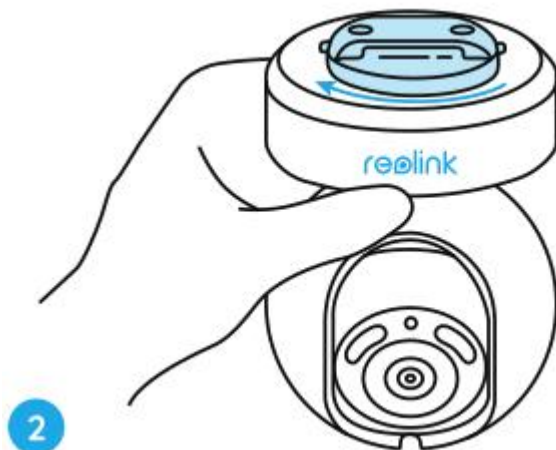

Step 3. Install the security mount.

Drill holes in accordance with the mounting template and screw the security mount to the wall.

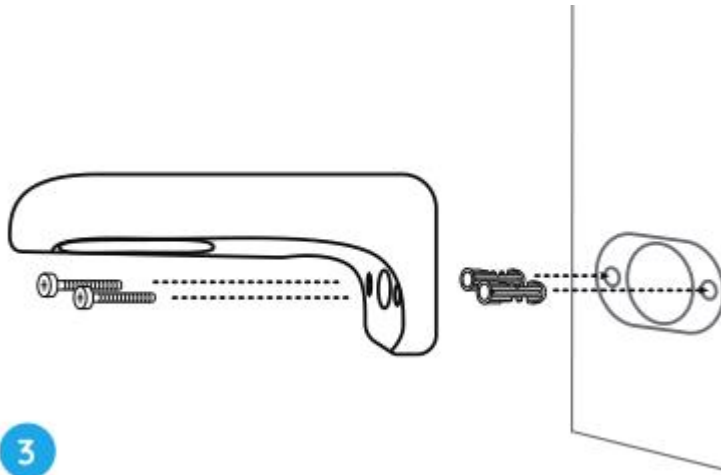

3

Note: Use the drywall anchors included in the package if needed.

Step 4. Fix the camera to the mount.

Align the bracket into the security mount perfectly. Then turn the base of the camera anti-clockwise, and you will hear a slight click sound which means the camera and the security mount have been correctly held together. Now you can turn the camera to determine a view angle for your camera.

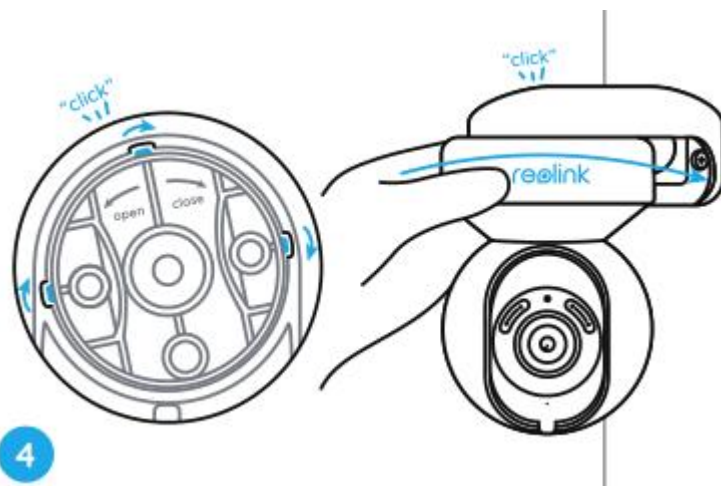

4

Note: Release your hand after you are sure that the camera is installed securely.

Mount the Camera on the Ceiling

First, refer to **Step 1** in **Mount the Camera on the Wall** to learn how to pull the button of the security mount and unscrew the ceiling bracket from the mount.

Step 1. Screw the ceiling bracket onto the ceiling.

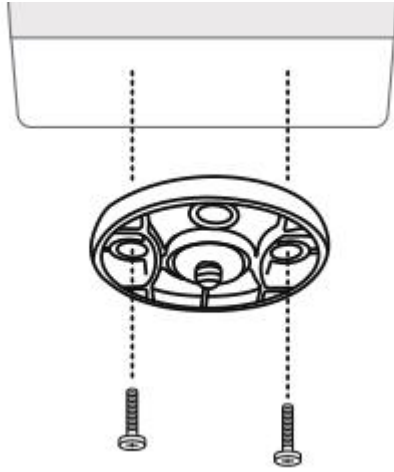

Step 2. Align the camera with the bracket and turn the camera unit clockwise to lock it in position.

